

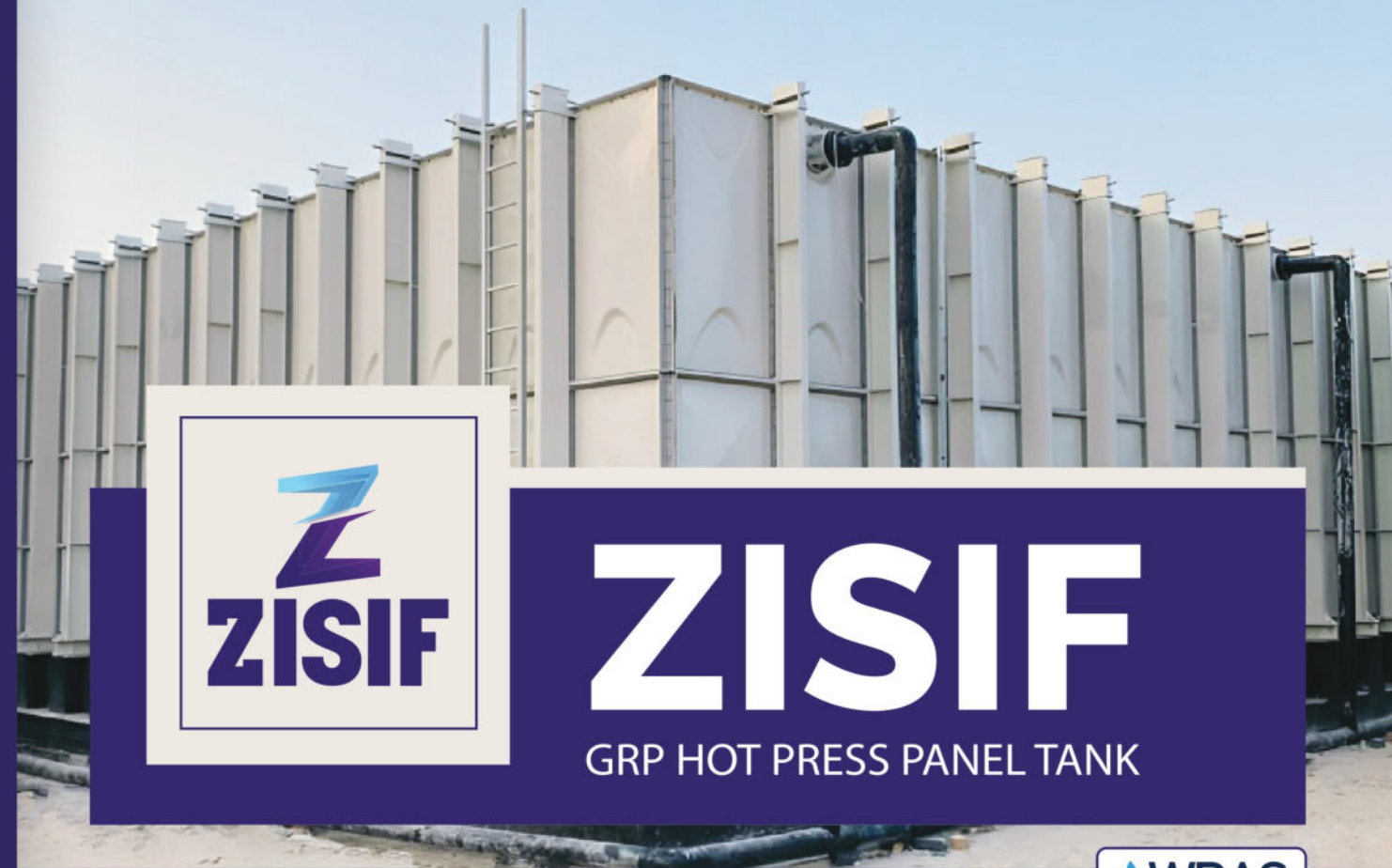

Since 1988

UNION FIBER GLASS FACTORY L.L.C



HO OFFICE LOCATION



WEBSITE



WHATSAPP



CONTACT US

DUBAI

+971 488 025 22
unionfbr@eim.ae

RAK

+971 725 894 54
sales@unionfibreglass.com

ABUDHABI

+971 25 8608 39
sales1@unionfibreglass.com

KSA {DAMMAM}

+966 5376 315 97
sales2@unionfibreglass.com

AFRICA

+211 928 353 644
anish@unionfibreglass.com

UK

+44 7552 4190 79
sales@unionfibreglass.com

ZISIF

GRP HOT PRESS PANEL TANK

MADE IN UAE





Table Of Content

Message from Founder	03
ZISIF GRP Hot Press Panel Tank	04
GRP Panel Composition by Height	07
Advantages	09
Steel Skid and Concrete Foundation	11
Comparison	12
External Reinforcement System	13
Internal Reinforcement System	15
Certificates	17
Accessories	18
Our Machineries	19
ZISIF Gallery	21
Choosing GRP is 'GO-Green'	22

Message from the Founder

We are delighted to introduce ourselves as one of the dedicated GRP products manufacturers, in the land of united Arab emirates . We are thriving in the industry since 1988, and are proud to be one of the leaders in the market , with high quality raw materials geared up by very skilled human resource pool.

ZISIF GRP Hot press panel tank is our flagship product , manufactured using In- house highly proved SMC line and heavy hydraulic press machines. We assure the quality in each step of the production.

We are continuously involved in the research of improving the quality of water storage by producing and supplying water tanks that are capable of maintaining water hygiene for a long duration , ruminating every drop of water, as the value of life .



Abdul Kader Kunhi Ahamed
(Managing Director)

We believe In maintaining our clients as our own family. Mutual trust and customer satisfaction will be our inspiration in the whole process. Affirming ourselves with the supply of excellent products and services as well as eco-friendly on the go; we also maintain ourselves with keeping intact high organizational culture .

ZISIF GRP Hot Press Panel Tank

Water is an essential element for our daily requirements such as drinking, cooking, and washing. It is also crucial for commercial purposes. However, the increasing demand for quality water has posed a significant challenge in water management, including preservation and storage. Traditional methods of water storage, such as RCC tanks and Steel tanks, are prone to issues like contamination and corrosion. That's where ZISIF GRP Hot Press Panel tanks come in. These tanks are designed with uncompromising quality and reliability, making them the ideal choice for various applications from individual homes to large-scale projects like hospitals and hotels. Made through hydraulic compression of sheet moulding compound; ZISIF tanks are physically strong and have a smooth finished surface. The modular design allows for easy assembly and construction, and they are known for their durability and stability. Additionally, GRP Hot Press Panel tanks are resistant to corrosion and the growth of algae, ensuring a constant supply of clean and hygienic water.



ZISIF

GRP Hot Press Panel Tank

Applications

- Residential Housing
- Commercial and Industrial Buildings
- Desalination and RO Plants
- Agricultural and Irrigation Tanks
- Rainwater Tanks
- Fire Fighting Storage
- Onshore and Offshore Oilfield water storage
- Hospital and schools etc.

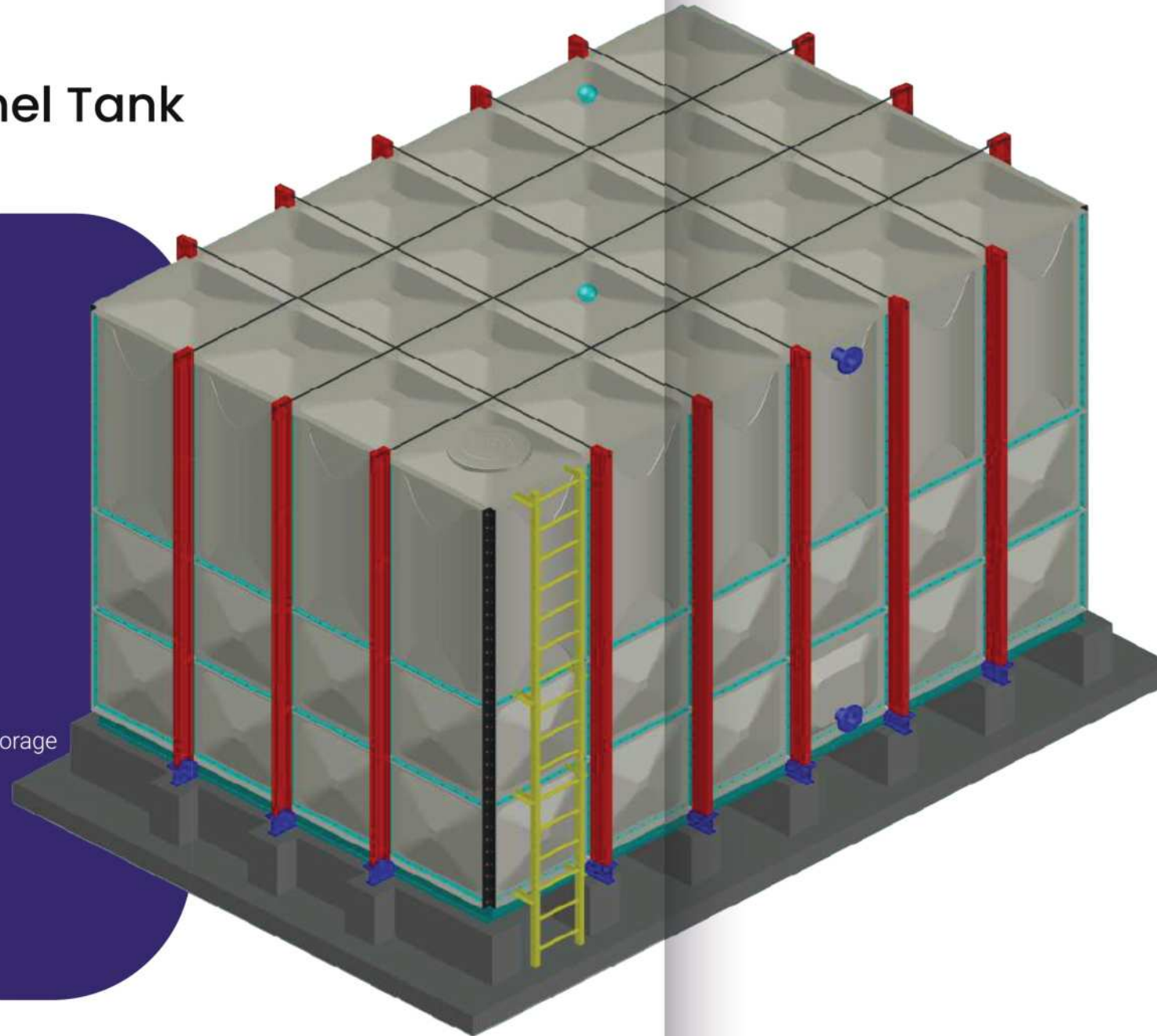

Features

Hot Press GRP Panel Tank

Moulding Temperature Up to 150°C

Base Resin: Isophthalic unsaturated polyester

Reinforcement: Type "E" glass Fiber

Standard

The sectional tank panels have been tested fully compliant with the requirements of SS 245 : 2014

Consistency of Quality

Optimized SMC (Sheet Moulding Compounds) for GRP Hot Press water tank panels are manufactured at our RAK factory.

6 times safety factor is ensured by in-house hydraulic pressure test.

Quality management procedures based on ISO 9001: 2015

GRP Panel Composition by Height

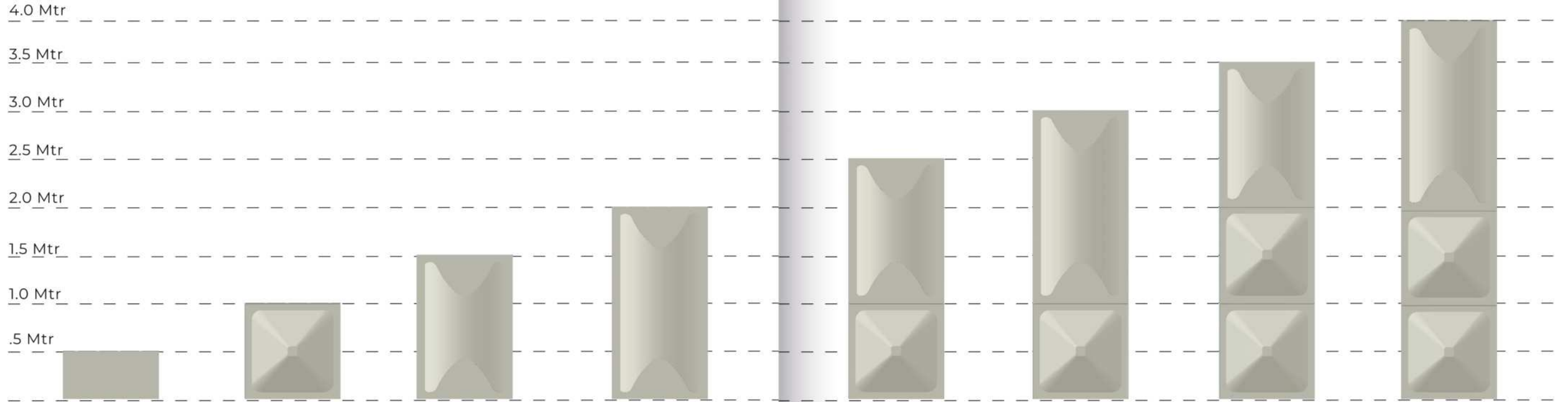

GRP Panel Types and Size

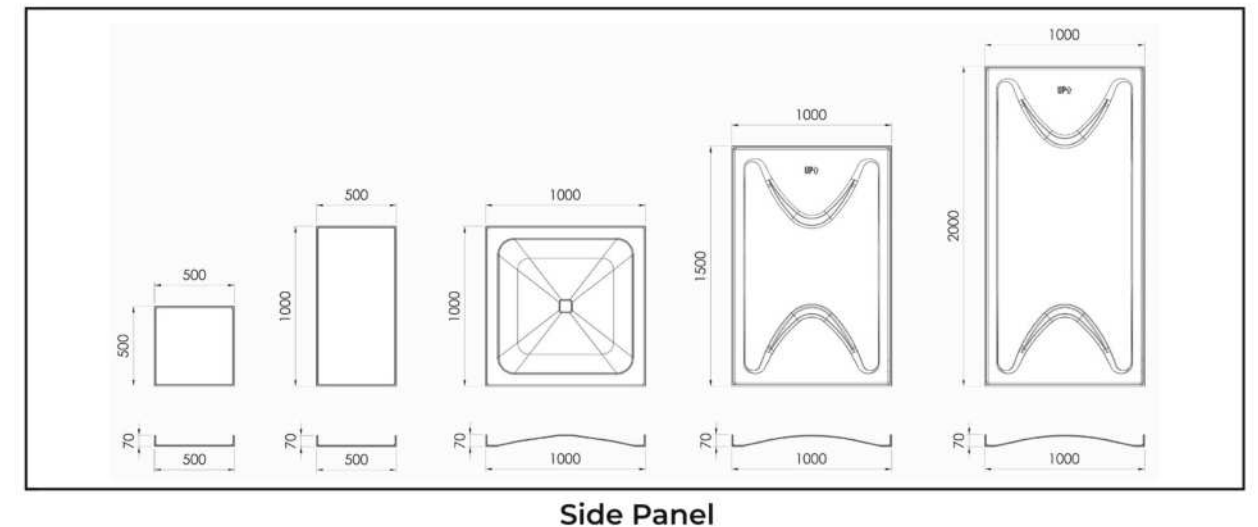
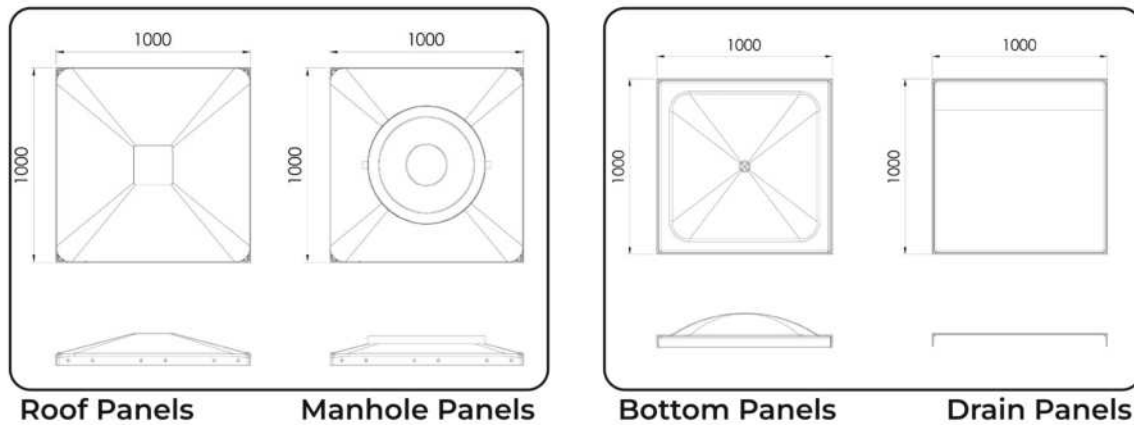

Advantages

Clean and Hygiene:

The GRP Panels offer exceptional resistance to corrosion and ensure a consistently smooth surface for the tank. They effectively prevent the growth of microbiological organisms and algae, making them ideal for long-term use. Additionally, the panels inhibit the formation of bacteria and germs due to minimal light transmission from outside.

Modular Design:

ZISIF GRP Hot Press Panel Tanks offer a flexible and modular design for large water storage tanks. Depending on the available space at the site, we can customize the tank's dimensions to maximize both horizontal and vertical space utilization.

Excellent Water Tightness:

Achieving a flawless water tightness in the water tanks is possible through the application of EPDM sealing gasket on the joints between the specially designed panels.

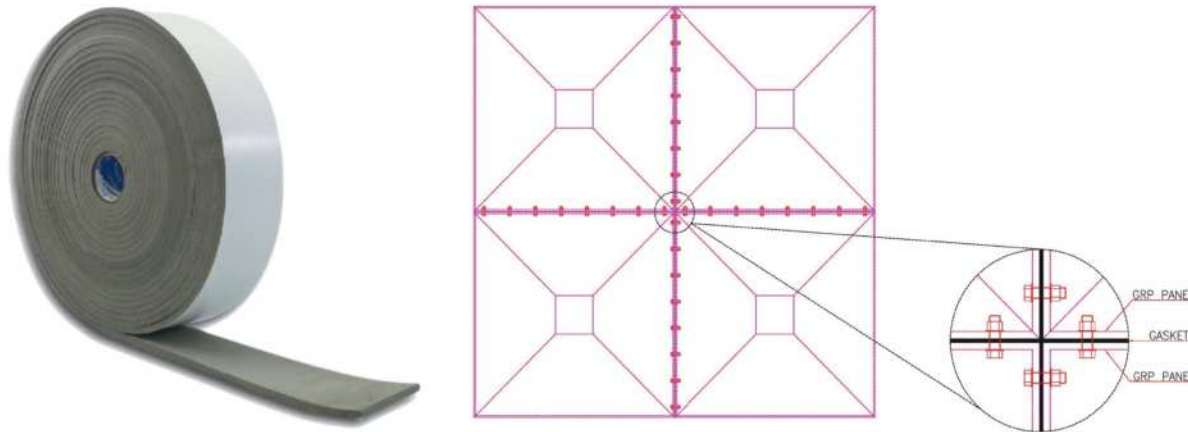

Durable & Endurance:

ZISIF GRP Panels are manufactured using a high-temperature and high-pressure moulding technique, guaranteeing maximum endurance. The steel structures utilized are exclusively stainless steel or HDG, known for their outstanding corrosion resistance.

Heat Insulated:

The GRP Panels have high heat insulation properties and can be further enhanced with PU Foam insulation upon request to prevent water temperature fluctuations based on the surrounding environmental conditions.

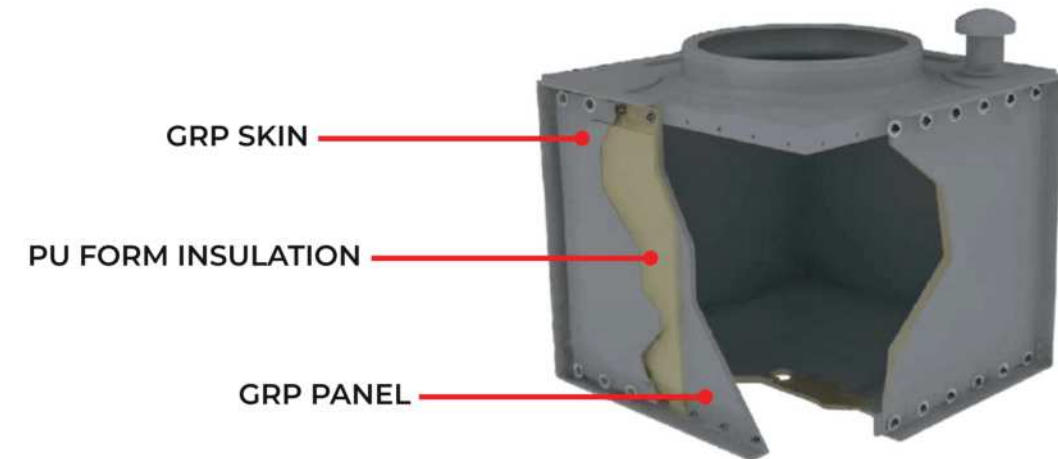

Easy to Move & Assemble:

The standardization of dimensions and weight in GRP panels makes transferring, moving, and carrying them much simpler. This will significantly reduce the construction time required for the tank. Additionally, the use of common tools for an easier bolting method will make the assembly and dismantling process effortless.

Steel Skid and Concrete Foundation

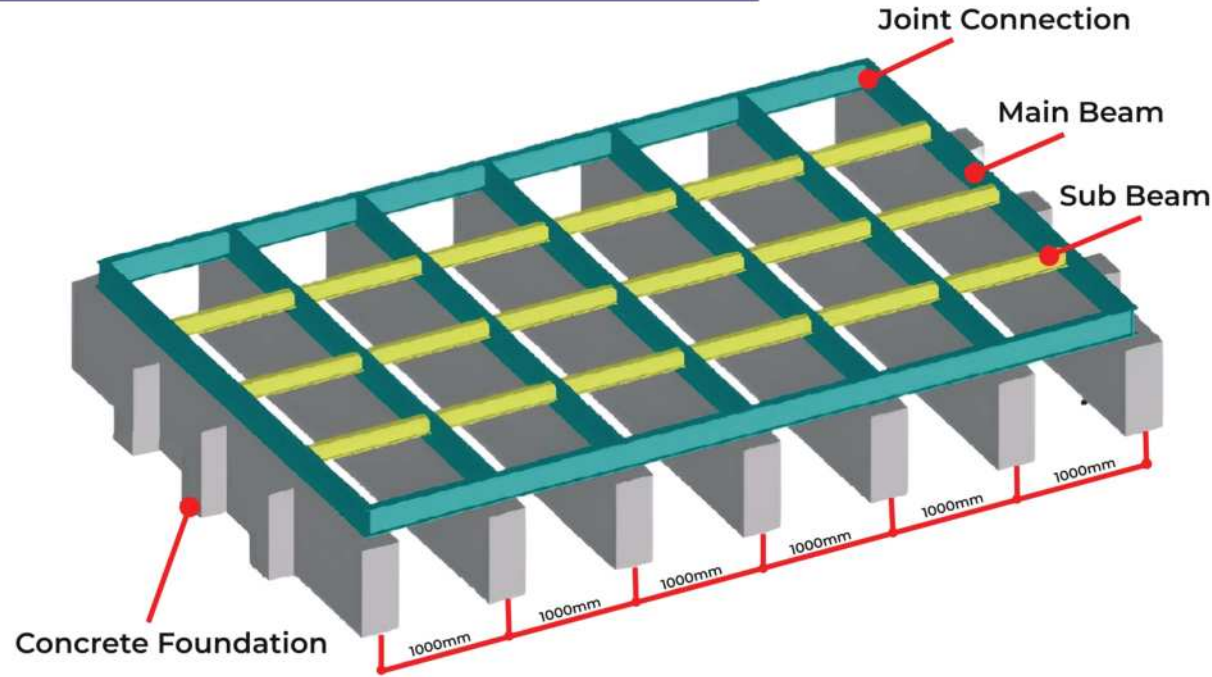

Steel Skid For Panel Tank - Details						
Item Name	Tank Height					
	1.5 Mter	2.0 Mter	2.5 Mter	3.0 Mter	3.5 Mter	4.0 Mter
 Main Beam	100x55x4.7mm I Beam	100x55x4.7mm I Beam	120x64x5mm I Beam	120x64x6.3mm I Beam	140x73x6.9mm I Beam	142x72x7.8mm I Beam
 Sub Beam	100x55x4.7mm I Beam	100x55x5mm I Beam	100x55x4.7mm I Beam	100x55x5.7mm I Beam	100x55x5.7mm I Beam	100x55x5.7mm I Beam

Equivalent substitute may be used based on the availability of the material

Comparison

ZISIF GRP Hot Press Panel Tank Comparison With Steel & RCC Tanks

	Concrete Tank	SS Sectional Tank	GRP Panel Tank
Durability	Fair	Good	Excellent
Water Quality	Poor	Good	Excellent
Water Tightness	Fair	Good	Excellent
Transport & assembly	Poor	Fair	Excellent
corosion and Resistance	Fair	Good	Excellent
Maintainance Freedom	Poor	Fair	Excellent
Cleaning	Poor	Good	Excellent
Fire Retardancy	Good	Poor	Excellent

ZISIF GRP Hot Press Panel Tank Phycical Properties

ZISIF Panel Properties					
SI No	Properties	Value	SI No	Properties	Value
1	Specific Gravity	1.8	6	Shear Strength	Min 870 kgf/cm
2	Glass Content	Min 32%	7	Water Absorption	Max 0.02%
3	Tensile Strength	Min 900 kgf/cm ²	8	Light Transmission	Nil
4	Flexual Strength	Min 1500 kgf/m ²	9	Toxicity	Nil
5	Barcol Hardness	Min 50	10	Micro Biological Growth	Nil



External Reinforcement System

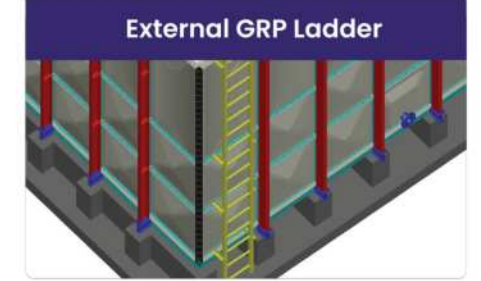
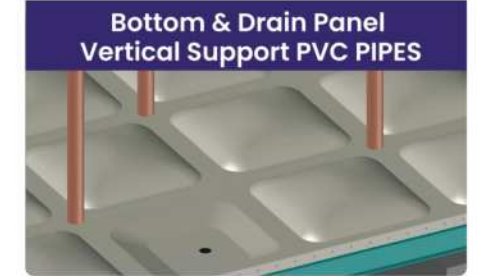
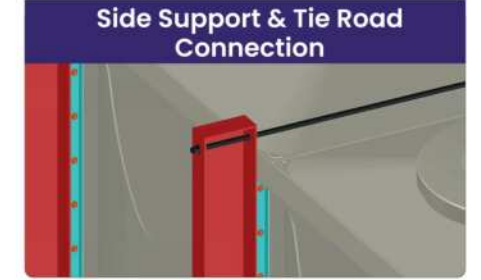
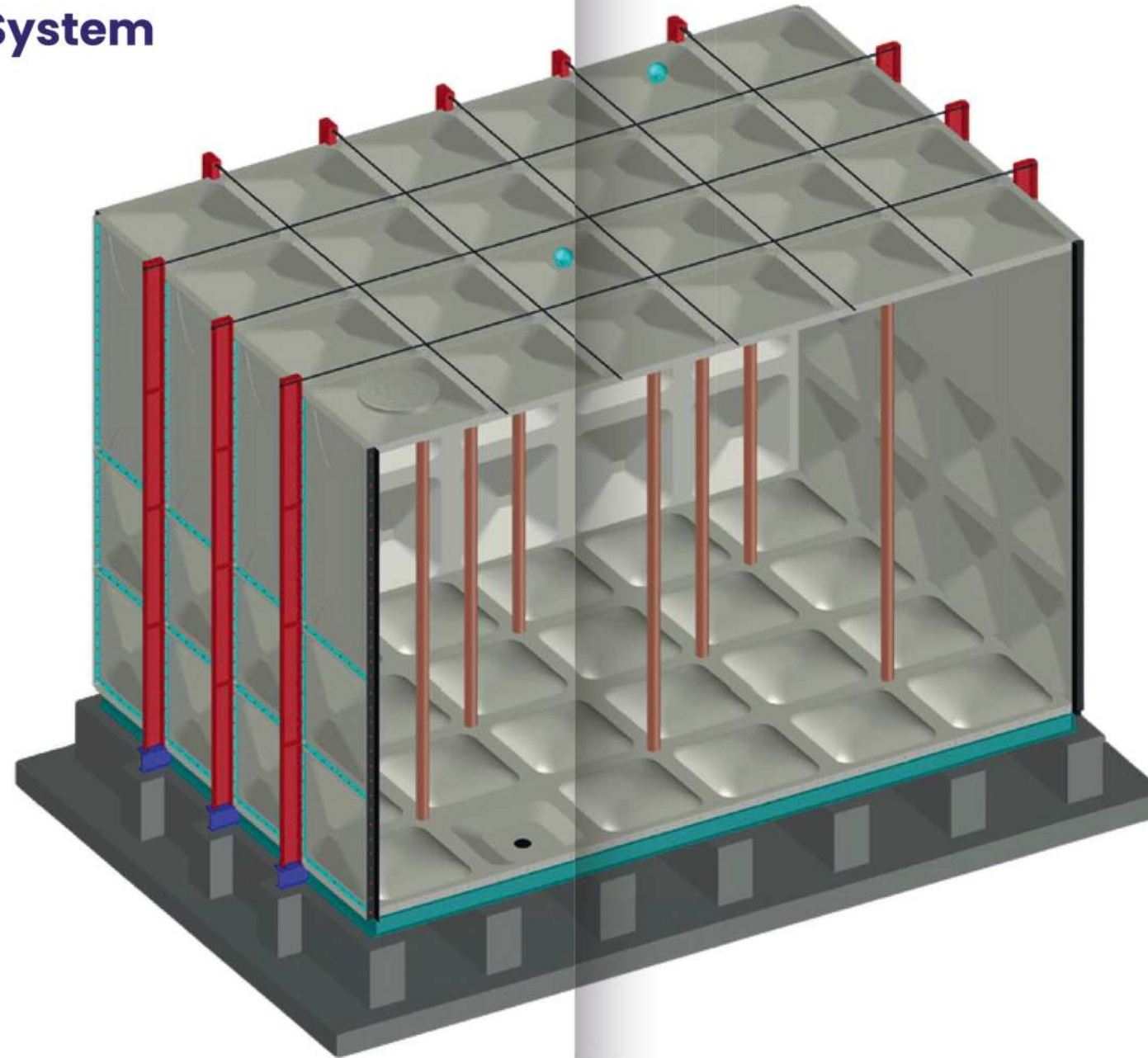
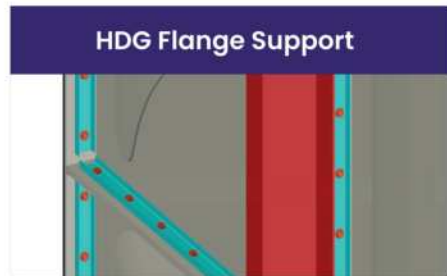
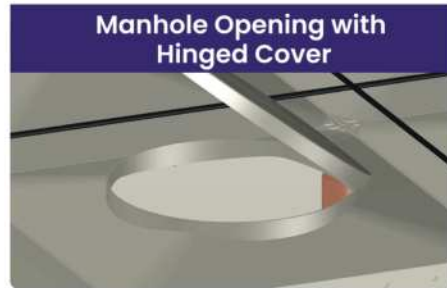

Internal Reinforcement System

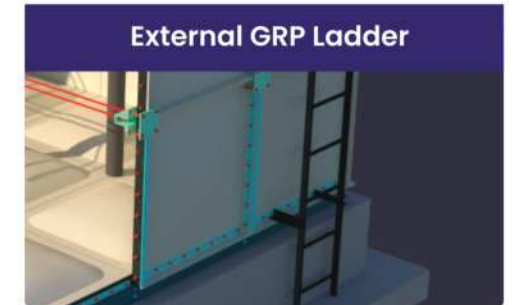
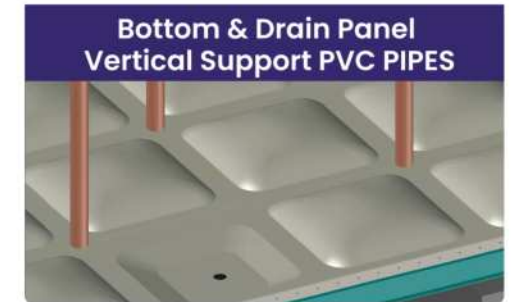
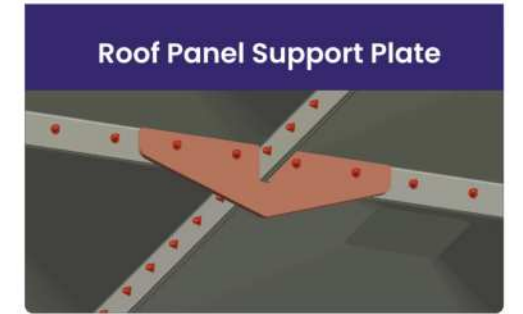
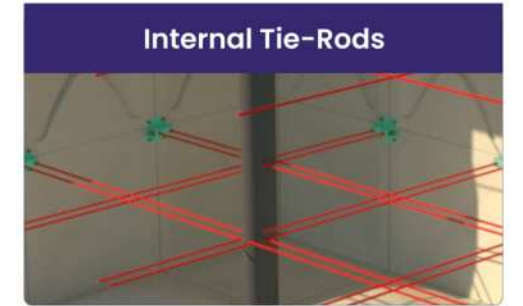
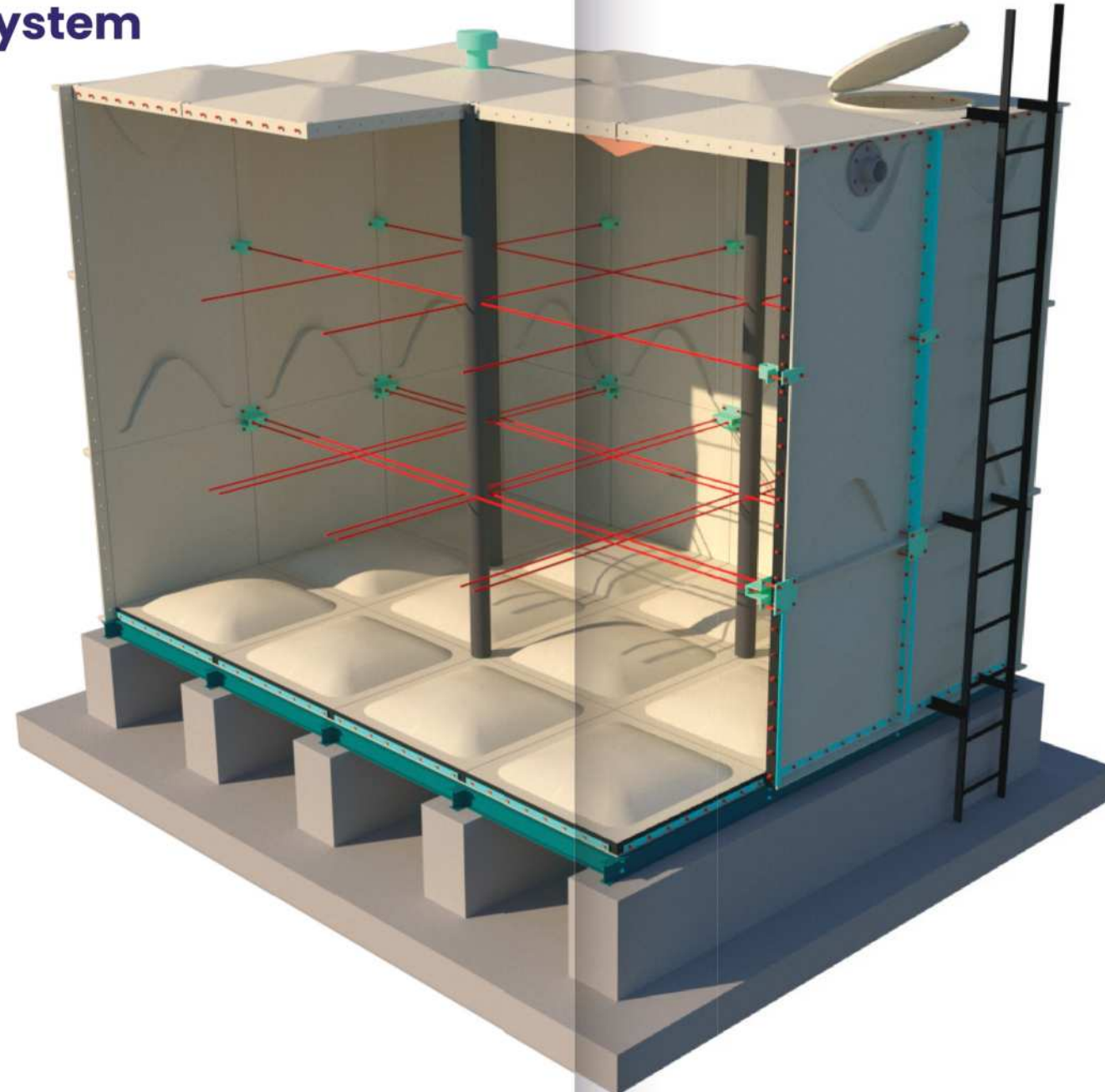

certificates



Accessories

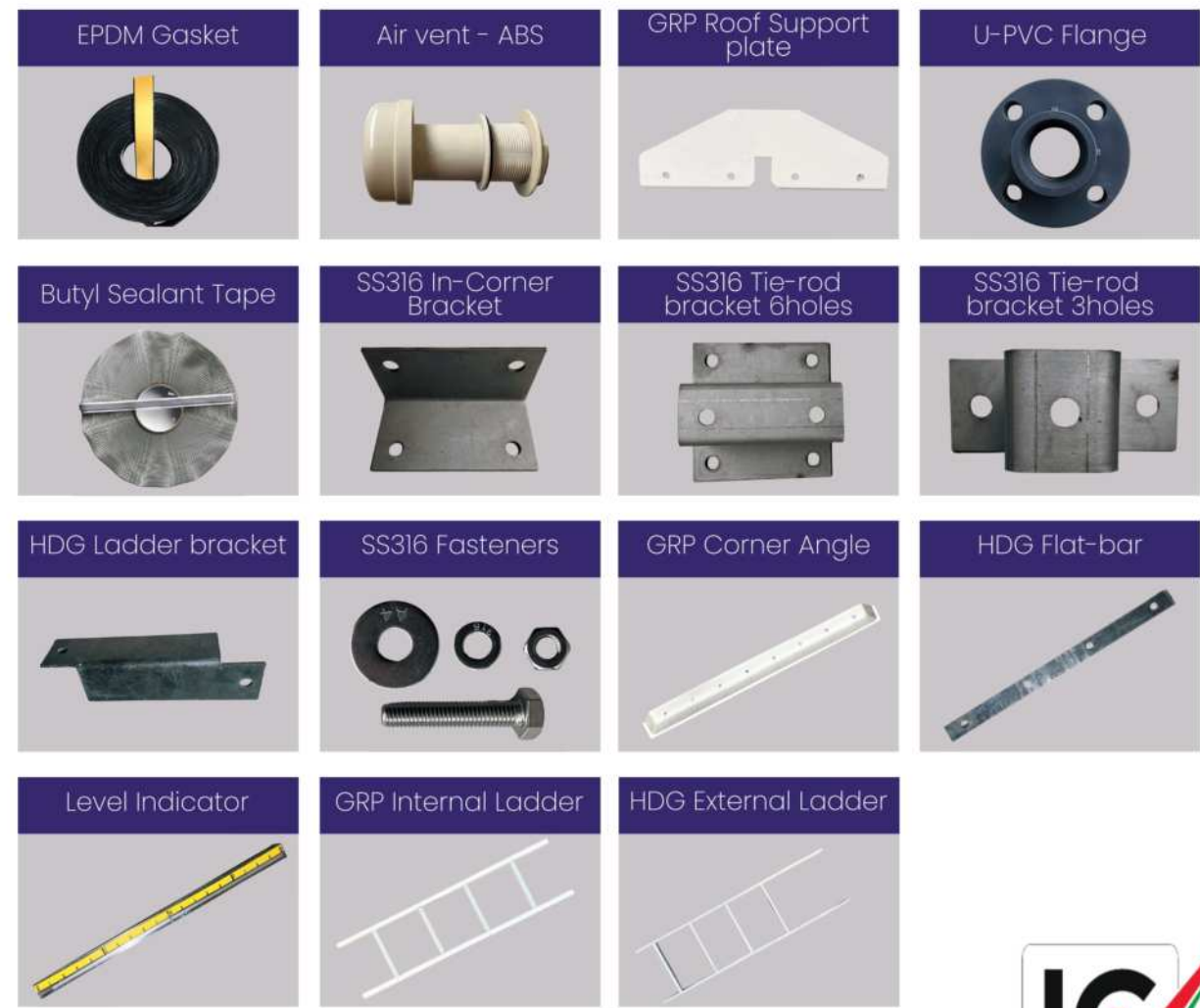

هيئة كهرباء ومياه دبي
Dubai Electricity & Water Authority



بلدية دبي
DUBAI MUNICIPALITY



Press machines



Press machine



SMC Line



Our Machineries

Drill Machine



Drill Machine



Hydraulic Pressure Tester



Press Brake for Accessories



CNC Machine for Accessories



Insulation Machine





ZISIF Gallery



ZISIF GRP Hot press panel tanks are
SUPPLYING ALL OVER THE WORLD



Choosing GRP is 'GO-Green'

- 01** Low embodied energy in the production of GRP Hot Press Panels 
- 02** High life cycle compared to other substitutes 
- 03** Lesser carbon footprint compared to other substitutes 
- 04** No harmful by-products 